

Data



e.cam Signature Series

It's about QUALITY. It's about SPEED. It's about COMFORT.

e.cam Signature Series



HD⁴ High Performance Detectors



e.soft^{turbo}



Flash 3D



e.media patient comfort and education system

Siemens e.cam[®] has earned an enviable reputation for outstanding image quality and clinical flexibility. Once again, Siemens sets a new standard of excellence with the introduction of the e.cam Signature Series.

The Signature Series encompasses the acclaimed features of the e.cam system — and adds enhanced performance, styling, and new options.

e.cam Signature Series improves your clinical performance and the patient's experience every step of the way.

- The new look of the Signature Series features subdued color accents, creating a more open and calm environment.
- HD⁴ detectors increase count rate performance and reliability, producing the most advanced digital detector.
- Our exclusive e.media option is the first-ever patient comfort and clinical education system, providing on-board interactive multimedia capability.
- Introducing Flash 3D, the most advanced SPECT iterative reconstruction technology available.
- e.soft[™] and syngo[®] combine to offer complete nuclear medicine acquisition and processing software, including image fusion and multimodality review.
- Nu.LOGIC[™] user-defined workflows improve department efficiency and throughput.
- e.soft P and e.soft^{turbo} workstations offer increased speed, capacity, and performance.
- Broad DICOM connectivity allows viewing of multimodality images side-by-side with nuclear medicine images.





e.cam Signature Series

It's about QUALITY. It's about SPEED. It's about COMFORT.



e.cam Variable Angle

e.cam Dual-Detector Variable-Angle

Allows for 180°, 90° and 76° detector configurations to optimize image quality for whole body, cardiac and general SPECT studies and high throughput for every acquisition type. The gantry, with its motion flexibility including caudal/cephalic detector tilt, offers full clinical utility for general purpose, cardiology, oncology, and neurology studies. The e.cam+ coincidence option is available for this camera.



e.cam Dual-Detector Fixed 180°

Optimized for both whole body and SPECT scanning with the detectors in opposing position, making it the ideal system for oncological applications. The open gantry permits easy access to both detectors for imaging of patients on gurneys and wheelchairs or in a standing position. The e.cam+ coincidence option is available for this camera.



e.cam Fixed 180°

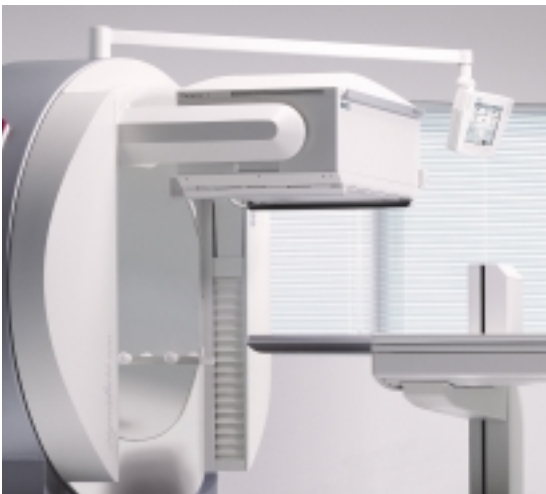

e.cam Single

e.cam Single

The e.cam single-detector system offers general purpose scanning flexibility with unrestricted access for gurneys and wheelchairs. This cost-effective system features a clinically versatile open gantry, caudal/cephalic detector tilt capability, automatic body contouring for SPECT and whole body scans, as well as upgrade paths to dual-head configurations.



e.cam Dual-Detector Multiangle Cardiac
Designed to meet the high-quality and high-throughput demands of cardiology practices. The optional Profile nonuniform cardiac attenuation correction accessory features a unique fixed multiple-line array that increases the accuracy of myocardial perfusion SPECT and enhances diagnostic confidence.

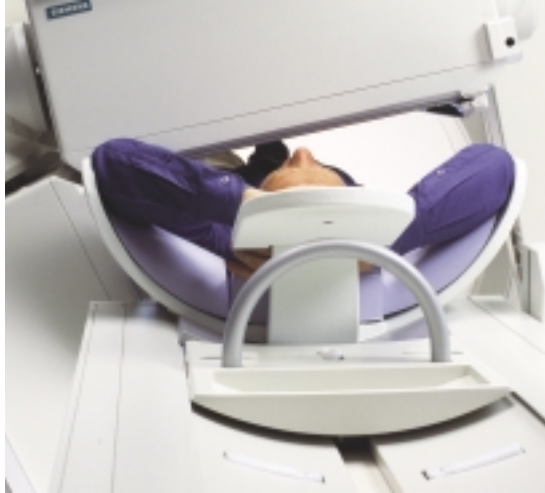

e.cam Multiangle Cardiac



e.cam ^{duet}

e.cam ^{duet} Multipurpose Camera System

The e.cam ^{duet} is a multipurpose camera specifically designed for both PET and single-photon applications. The system utilizes a 25.4 mm (1.0 inch) segmented NaI crystal along with sophisticated electronics to achieve exceptional high performance. The result is a system that offers superior performance at low-, medium-, and high-energies.



e.cam Single Standard

This system is an economical choice for general nuclear medicine applications. The single detector design allows patient imaging on gurneys and wheelchairs. Upgrade paths to additional e.cam features are available.



e.cam Single Standard

e.cam Signature Series

It's about Quality.



HD⁴ High-Performance Detector
The state-of-the-art design provides increased performance, reliability, and serviceability.

e.media
The integrated DVD player and the redesigned Patient Positioning Monitor (PPM) combine to give e.media unlimited possibilities.

Collimators
e.cam offers a comprehensive selection of collimators for general and specialized applications. Siemens automated fabrication process assures high uniformity and precise angulation.

Enhanced Patient Bed
The e.cam patient bed, featuring an ultrathin imaging pallet, is designed for ease-of-use, patient comfort, and image quality. Optional pallets add versatility.

Coincidence Acquisition
Ultra-high-efficiency HD⁴ detectors, special high count rate electronics, and axial shields to reduce scatter and random coincidence events combine to provide complete coincidence acquisition and processing functionality.

Profile Attenuation Correction
The unique, multiple-line source array produces a profiled transmission source shape, effectively correcting myocardial perfusion SPECT studies for non uniform attenuation from organs surrounding the heart.





HD⁴ High-Definition Dynamic Digital Detector

System Specifications



The HD⁴ detector provides increased performance, reliability, and serviceability.

- Faster electronics increase count rate performance.
- Significant increase in reliability, resulting in maximum time between service calls.

Coincidence Specifications	crystal thickness	
	5/8"	1.0" (segmented)
Maximum Singles Count Rate (per detector)	≥ 2.9 Mcps	≥ 2.9 Mcps
Maximum NEC Count Rate (70 cm whole body phantom)	≥ 1.0 kcps	≥ 2.5 kcps
Scatter Fraction	≤ 14%	≤ 19%
Reconstructed Resolution		
FWHM Central Axial	≤ 4.2 mm	≤ 4.7 mm
FWHM Central Transaxial	≤ 4.8 mm	≤ 5.3 mm
System Sensitivity	11 kcps/μCi/ml	30 kcps/μCi/ml
300 kcps/Mbq/ml	300 kcps/Mbq/ml	804 kcps/Mbq/ml
Coincidence Timing Window	2t = 12 nsec	2t = 12 nsec

NEMA Performance Measurements of Scintillation Cameras
All values are determined at the manufacturer's facility, using the methods described in "NEMA Standards Publication for Performance Measurements of Scintillation Cameras." Elaborate measurement equipment is required in order to comply with these standards.

Due to this requirement, these standards are not intended for acceptance testing at installation or for use as a user-quality-control or quality-assurance procedure. All measurements made with a 20% energy window.

Coincidence values are measured in accordance with NEMA Standards Publication NU-2 1994 using coincidence mode (photopeak-photopeak) @ 511keV with the exception of Maximum NEC Count Rate which is measured using NEMA Standards Publication NU-2 2001.

Detector Specifications	crystal thickness		
	3/8 "	5/8"	1.0"
Performance Standards (worst case specification) (segmented)			
Intrinsic Spatial Resolution			
FWHM in CFOV	≤ 3.8 mm	≤ 4.5 mm	≤ 5.5 mm
FWHM in UFOV	≤ 3.9 mm	≤ 4.6 mm	≤ 5.6 mm
FWTM in CFOV	≤ 7.5 mm	≤ 8.7 mm	≤ 10.4 mm
FWTM in UFOV	≤ 7.7 mm	≤ 8.9 mm	≤ 10.6 mm
Intrinsic Spatial Linearity			
Differential in CFOV	≤ 0.2 mm	≤ 0.2 mm	≤ 0.3 mm
Differential in UFOV	≤ 0.2 mm	≤ 0.2 mm	≤ 0.35 mm
Absolute in CFOV	≤ 0.4 mm	≤ 0.5 mm	≤ 0.5 mm
Absolute in UFOV	≤ 0.7 mm	≤ 1.0 mm	≤ 1.5 mm
Intrinsic Energy Resolution FWHM in UFOV	≤ 9.9%	≤ 9.9%	≤ 10.4%
Intrinsic Flood Field Uniformity (uncorrected)			
Differential in CFOV	≤ 2.5%	≤ 2.5%	≤ 2.5% [†]
Differential in UFOV	≤ 2.7%	≤ 2.7%	≤ 2.7% [†]
Integral in CFOV	≤ 2.9%	≤ 2.9%	≤ 2.9% [†]
Integral in UFOV	≤ 3.7%	≤ 3.7%	≤ 3.7% [†]
Multiple Window Spatial Registration	≤ 0.6 mm	≤ 1.0 mm	≤ 1.8 mm

Class Standards

Intrinsic Count Rate Performance in Air			
Maximum Count Rate	310 kcps	310 kcps	275 kcps
Intrinsic Spatial Resolution @ 75 kcps			
FWHM in UFOV	≤ 4.1 mm	≤ 4.6 mm	≤ 5.6 mm
FWTM in UFOV	≤ 7.8 mm	≤ 8.9 mm	≤ 10.6 mm
Intrinsic Flood Field Uniformity @ 75 kcps (uncorrected)			
Differential in CFOV	≤ 2.5%	≤ 2.5%	≤ 2.5% [†]
Differential in UFOV	≤ 2.7%	≤ 2.7%	≤ 2.7% [†]
Integral in CFOV	≤ 2.9%	≤ 2.9%	≤ 2.9% [†]
Integral in UFOV	≤ 3.7%	≤ 3.7%	≤ 3.7% [†]
System Spatial Resolution without Scatter with LEHR Collimator at 10 cm			
FWHM in CFOV	7.4 mm	7.8 mm	8.5 mm
FWTM in CFOV	14.1mm	14.9 mm	16.0 mm
System Spatial Resolution with Scatter with LEHR Collimator at 10 cm			
FWHM in CFOV	8.7 mm	8.9 mm	9.7 mm
FWTM in CFOV	19.1 mm	19.5 mm	20.9 mm
System Planar Sensitivity with LEHR Collimator at 10 cm			
Absolute	202 cpm/μCi	225 cpm/μCi	230 cpm/μCi
System Planar Sensitivity with MELP Collimator at 10 cm (In 111) (both energy windows at 20%)			
Absolute	430 cpm/μCi	565 cpm/μCi	628 cpm/μCi

SPECT

Class Standards

Reconstructed Spatial Resolution with Scatter with LEHR Collimator			
Center	≤ 11.4 mm	≤ 11.5 mm	≤ 12.0 mm
Radial	≤ 11.7 mm	≤ 12.0 mm	≤ 12.3 mm
Tangential	≤ 8.4 mm	≤ 8.8 mm	≤ 9.2 mm

[†] Corrected for Uniformity

HD⁴ High-Definition Dynamic Digital Detector and Gantry Physical Specifications

Field-of-View (FOV)	53.3 x 38.7 cm (21 x 15.25 in.)
Diagonal FOV	63.5 cm (25 in.)
e.cam duet FOV	52.8 x 37.7 cm (20.8 x 14.8 in.)
Crystal	
Size	59.1 x 44.5 cm (23 x 17.4 in.)
Diagonal	69.2 cm (27 in.)
Thickness	9.5 mm (3/8 in.) or 15.9 mm (5/8 in.) or 25.4 mm (1 in.)
Photomultiplier Tubes	
Total Number	59
Diameter	53-7.6 cm (3 in.) 6-5.1 cm (2 in.)
Type	bialkali high-efficiency box-type dynodes
Array	hexagonal
Shielding	
Back	9.5 mm (0.375 in.)
Sides	12.7 mm (0.5 in.)
Min. and Max. in patient direction	27.9-36.4 mm (1.1-1.435 in.)
(For any point on the pallet at maximum 183 cm (6 ft.) from detector while the detector is at 25.4 cm (10 in.) radial position.)	
Brain Reach	
Distance from edge of detector housing to edge of FOV	7.6 cm (3 in.)
Height	193.0 cm (6 ft. 4 in.)
Width	167.6 cm (5 ft. 6 in.)
Depth	159.4 cm (5 ft. 2.75 in.)
Axis of Rotation (from Floor)	99.0 cm (3 ft. 3 in.)
Weight High-Energy Collimator	1755 kg (3900 lb.) Dual Det. 1170 kg (2600 lb.) Single Det.
Min. Patient Opening (HE Coll.)	9.0 cm (3.5 in.)
Min. Patient Opening (HR Coll.)	14.0 cm (5.5 in.)
Max. Patient Opening (HE Coll.)	62.0 cm (24.4 in.)
Max. Patient Opening (HR Coll.)	67.0 cm (26.4 in.)
Average Autocontour Distance	1.1 cm (0.45 in.)
Max. Radial Speed	120 cm/min. (47.2 in./min.)
Max. Lateral Position Left***	5.1 cm (2 in.)
Max. Lateral Position Right***	22.9 cm (9 in.)
Max. Lateral Speed	120 cm/min. (47.2 in./min.)

Single-Head, Dual-Head 180° and Dual-Head Variable-Angle (180°)

Max. CW Rotation Det. 1*	440°
Max. CCW Rotation Det. 1*	30°

Variable-Angle and Multiangle Cardiac (90°)

Max. CW Rotation Det. 1**	350°
Max. CCW Rotation Det. 1**	120°
Ring Rotation Range	470°
Rotational Accuracy	0.1°
Max. Rotational Speed	3 RPM
Min. Rotational Speed	0.33 RPM
Center of Rotation	≤ 0.25 pixel (64 x 64 matrix)
Max. Caudal Tilt (Outward)****	90°
Max. Cephalic Tilt (Inward)****	20°

Outer Room Positions*****

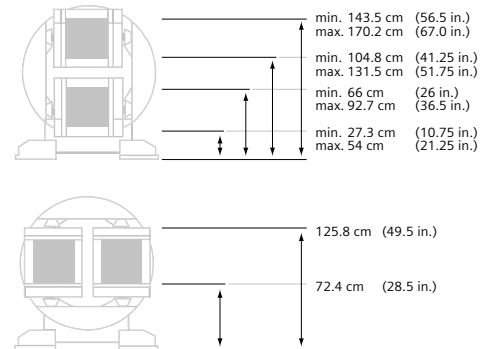

Electronics Enclosure

Height	105.4 cm (41.5 in.)
Width	55.9 cm (22 in.)
Depth	52.3 cm (20.25 in.)
Weight	99 kg (220 lb.)

System Environmental Requirements

Floor Loading Single-Head and Dual-Head	0.073 kg/sq. cm (150 lb/sq. ft.)
	200-240 Volt (±10%), 50-60 Hz
	3.0 kVa, 30 Amp
	single phase service
Heat Dissipation	7200K Joules/hr. (6800 BTU/hr.)
Temperature Range	15.5°-35°C (60°-95°F)
Max. Temperature Variance	4.4°C/hr. (8°F/hr.)
Humidity	15-80% noncondensing

* As seen from patient bed side, detectors at 180° opposed position, start with detector 1 on top.

** As seen from patient bed side, detectors at 90° cardiac position, start with detector 1 on top.

*** As seen from patient bed side. Gantry lateral motion for dual-head systems only.

**** Patient on patient bed with feet in gantry, with low-energy collimators.

***** Available with all collimators.

Patient Positioning Monitor

e.media Patient Comfort and Education Package

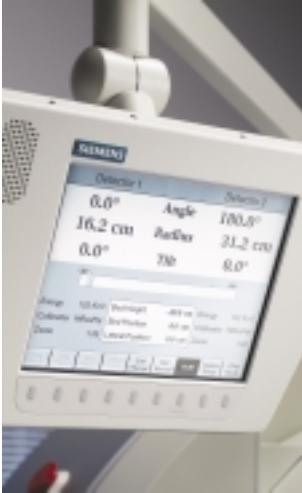

LCD Flat Panel Display — Patient Positioning Monitor

The e.cam system flat display panel is mounted on an arm (boom) extending from the top of the gantry. The display panel arm can be moved to either side of the gantry, with the display panel itself swiveling in a left-right direction, along with a reasonable amount of tilt. The display screens available on the display panel include: Persistence Mode, Gantry Mode, Persistence During Acquisition, and Gantry During Acquisition.

Flat panel display information includes:

- Rotation Angle
- Detector Radius
- Detector Tilt
- Elapsed Time
- View Number
- Count Rate
- Matrix Size
- Collimator Change
- Offset Zoom
- Time Remaining
- SPECT/Coincidence Mode
- Patient Bed Height
- Persistence Mode
- Gantry Lateral Position
- Patient Bed Position
- Patient Positioning Monitor
- Analyzer Energy Setting
- Window and Persistence Adjustment
- 30.5 cm (12 in.) Monitor Screen
- Profile Attenuation Source "On" Indicator



Optional e.media Patient Comfort and Education Package

e.media offers unlimited possibilities for patients and institutions. The integrated DVD-ROM plays high-quality video and sound through the redesigned Patient Positioning Monitor. The critical area where e.media can make an impact is in patient comfort. Relaxing or interesting video presentations can translate into less patient movement. Less patient movement means less repeat scans and better image quality. Less repeat scans and better image quality create a winning situation for everyone —patients, technologists, and physicians.

Examples of the material that can be displayed:

- Relaxation videos and music
- Entertainment for young patients
- Patient procedure information
- Audio CD-ROMs
- Hospital promotional videos
- Staff training videos



Video Specifications	
- DVD Player	Sony DVP F-Series
- Playback Formats	DVD Video, CD Audio, Video CD
- D/A Converter	10 bit / 27 MHz
- Format	NTSC/PAL
Audio Specifications	
- D/A Converter	24 bit / 96 KHz
- Output Terminals	S-Video, Composite Video, Digital Audio, Analog Stereo
Convenience	
	Instant Replay, Smooth Scan, Smooth Slow, Sound Feedback
General	
- Power	220-240V AC, 50/60 Hz
- Dimensions (w x h x d)	252 x 60 x 183 mm
- Weight	1.5 kg





Collimators

To Suit All Your Imaging Needs



Versatile Design

e.cam provides a comprehensive selection of collimators for general and specialized applications. Siemens fully-automated robotic core fabrication process assures high uniformity and precise angulation. The collimator exchange system is designed to allow even the heaviest collimators to glide quickly, easily and smoothly into place.



Collimators	LEHS Low-Energy High-Sensitivity ^{99m} Tc	LEAP Low-Energy All-Purpose ^{99m} Tc	LEHR Low-Energy High-Resolution ^{99m} Tc	LEUHR Low-Energy Ultrahigh-Resolution ^{99m} Tc	LEFB Low-Energy Fanbeam ^{99m} Tc	MELP Medium-Energy Low Penetration ⁶⁷ Ga	HE High-Energy ¹³¹ I	UHE Ultrahigh-Energy ¹⁸ F
Isotope								
Hole Shape	Hex	Hex	Hex	Hex	Hex	Hex	Hex	Hex
Number of Holes (x 1,000)	28	90	148	146	64	14	8	4
Hole Length (mm)	24.05	24.1	24.05	35.8	35	40.64	50.8	50.5
Septal Thickness (mm)	0.36	0.20	0.16	0.13	0.16	1.14	2	3.4
Hole Diameter (mm across the flats)	2.54	1.45	1.11	1.16	1.53	2.94	3.4	2.5
Sensitivity @ 10 cm (cpm/μCi) ¹	1020	330	202	100	300	310	135	185
Geometric Resolution @ 10 cm (mm)	14.6	8.3	6.4	4.6	8.8/8.3 ²	10.8	12.6	10.6
System Resolution @ 10 cm (mm) ²	15.6	9.4	7.4	6.0	9.6/8.7 ²	12.5	14.5	19.0
Septal Penetration (%)	1.5	1.9	1.5	0.8	1	1.2	3.5	3.4
Focal Length @ Exit Surface (mm)	n.a.	n.a.	n.a.	n.a.	445	n.a.	n.a.	n.a.
Weight in lb.	42	49	45	56	67	136	245	260
Weight in kg	18.9	22.1	20.4	25.2	30.5	61.8	111.1	117.0

1. Values measured in accordance with NEMA Standards Publication NU-2 1994 using 3/8" crystal.

2. Axial/Transverse resolution of 15.2 cm (6 in.).

Pinhole Collimator	isotope		
	^{99m} Tc	¹²³ I	¹³¹ I
Hole Shape	Round	Round	Round
Number of Holes	1	1	1
Hole Diameter (mm)	4,6,8	4,6,8	4,6,8
Cone length (approx. in mm)	200	200	200
Diameter at Base of Cone (approx. in mm)	300	300	300
Sensitivity @ 10 cm with 4 mm (cpm/μCi)	123	111	67
Sensitivity @ 10 cm with 6 mm (cpm/μCi)	271	243	133
Sensitivity @ 10 cm with 8 mm (cpm/μCi)	478	426	221
Geometric Res. @ 10 cm with 4 mm (mm)	6.2	6.3	7.5
Geometric Res. @ 10 cm with 6 mm (mm)	9.3	9.3	10.6
Geometric Res. @ 10 cm with 8 mm (mm)	12.3	12.4	13.6
System Res. @ 10 cm with 4 mm (mm)	6.6	6.6	7.6
System Res. @ 10 cm with 6 mm (mm)	9.5	9.5	10.7
System Res. @ 10 cm with 8 mm (mm)	12.5	12.5	13.7
Weight in lb.	165	165	165
Weight in kg	74.3	74.3	74.3

Semi-Automatic Collimator Server

It's about Speed.



BiCore™ Collimators

A wide variety of optional collimators are available for all energies and include Ultrahigh-Energy, Fanbeam, and Pinhole. The unique collimator exchange combines fully automated collimator installation with rapid (manual) insertion. The collimator server supports up to four collimator cores, providing the operator with the ability to remove and install two sets of collimators from the same cart, eliminating one trip to and from the collimator storage area. The collimators are vertically mounted to conserve department space.

Collimator Server (w/o collimators)		
Height	132.1 cm	(4 ft. 4 in.)
Width	110.5 cm	(2 ft. 7.5 in.)
Depth	110.5 cm	(2 ft. 7.5 in.)
Weight	120.2 kg	(265 lb.)

For dual-detector systems, the collimator server is designed to hold two sets of collimators (or one set of collimators and one pinhole collimator). For single-detector systems, the collimator server can hold up to four collimators (or two collimators and a pinhole collimator). All servers enable easy storage, transport, installation and removal of collimators.

Patient Handling System

It's about Comfort.



Versatile Design

The e.cam's motorized patient bed supports a variety of patient weights and sizes—up to 180 kg (400 lb), meeting the needs of a wide range of clinical applications. The low attenuation characteristics of the ultrathin pallets and the close proximity of the detector to the patient optimize study resolution. The patient bed lowers to a convenient 48.3 cm (19 in.) for easy patient access. Both the bed and the optional pallets, along with such features as easy field-of-view indicators, a built-in patient bed ruler, reconfigurable arm supports, brain SPECT headholder, and cardiac armrests provide patient comfort during the scan.



Easy Configuration

The patient bed (shown on left with the standard pallet) can be configured with right- or left-side patient access to accommodate site-specific installation requirements. The bed is easily removed for rail-free access to imaging patients on gurneys or wheelchairs. It comes equipped with a head holder, a cardiac arm rest, a built-in patient bed ruler, and a contoured patient pad. Also, the ECG connector and power outlet are located at the base of the patient bed where an external ECG monitor can be connected.



Patient Comfort Accessories

The cardiac arm rest provides a comfortable resting area for the patient's elbows when positioned over the head, thus reducing patient movement during acquisition. The head holder, which mounts to the top of the patient bed pallet's front end, supports the patient's head and reduces head movement during brain scanning. Optional dedicated pallets for pediatric and scintimammography applications are also available.



e.cam Signature Series

Patient Bed Features

Specifications

Patient Bed

Width	88.9 cm (35.4 in.)
Length	251.5 cm (99 in.)
Weight	253 kg (562 lb.)
Height	109.2 cm (43 in.)
Vertical Motion Range	48.3-110.5 cm (19.0-43.5 in.)
Maximum Vertical Speed	120 cm/min. (47.2 in./min.)
Pallet Material	Aluminum
Pallet Thickness	2.54 mm (0.10 in.)
Pallet Width SPECT	35.6 cm (14 in.)
Pallet Width Whole Body	64.8 cm (25.5 in.)
Attenuation @ 140 keV	< 7%
Max. Patient Weight	180 kg (400 lb.)
Max. Deflection of Patient Pallet	< 3.2 mm (< 0.125 in.)
Max. Scan Length in Whole Body Mode	202 cm (79.5 in.)
Horizontal Motion Range	164.5 cm (5 ft. 4.75 in.)
Horizontal Motion Accuracy	0.4 mm (0.016 in.)
Maximum Horizontal Speed	240 cm/min. (94.5 in./min.)
Minimum Horizontal Speed	0.1 cm/min. (0.040 in./min.)

Rear Pallet Support

Width	35.6 cm (14 in.)
Length (with bar in)	124.5 cm (49 in.)
Length (with bar out)	153.7 cm (60.5 in.)
Weight	49 kg (109 lb.)

ECG Input

- TTL Signal Input
- 0 to +5 Volt
- Negative and Positive Trigger

ECG Gating

- Forward or Forward/Backward by Thirds Framing in Planar Mode
- Forward or Forward/Backward by Thirds by Percentage Framing in SPECT Mode
- Buffered Beat Window
- Bad Beat Rejection
- Number of Frames per R-R Interval or Milliseconds per Frame
- Automatic or Manual Selection of Beats Acceptance Window
- Integrated EGG Port Conveniently Plugs into Bed, Eliminating Any Cable Obstruction

Integrated Source Holder

At the back of the e.cam gantry is the rear pallet support which is used to support the patient bed pallet as it travels through the gantry. This rear pallet support can be flipped up and out of the way when the patient bed is at its lowest position and detector 1 is at 0° rotation. The rear bed also contains the safety rail, which is used to keep personnel from moving behind the gantry where possible contact could occur with the pallet. A source holder is integrated into this rear bed for detector energy peaking, tuning and other quality control procedures. This source holder was specifically designed to perform intrinsic quality control procedures on both detectors simultaneously.

Mammography Pallet

The specialized mammography pallet design is easily installed on the patient bed and allows for scintimammography acquisitions in both planar and SPECT mode. The patient is in a prone head-in position, and does not need to get off the pallet to change from left to right lateral/oblique views.

Width	35.6 cm (14 in.)
Length	170.2 cm (67 in.)
Weight	4.7 kg (10.5 lb.)
Height	12.7 cm (5 in.)
Pallet Material	Carbon Fiber/Foam/Laminated Wood
Pallet Thickness	2.54/12.7/38.1mm (0.1/0.5/1.5 in.)
Pallet Width SPECT	35.6 cm (14 in.)
Attenuation @ 140 keV	<8.5%
Max. Patient Weight	135 kg (300 lb.)
Max. Deflection of Patient Pallet	<12.7mm (<0.5 in.)

Pediatric Pallet

Designed for use with the e.cam Patient Handling System to image infants in planar or SPECT mode, the pediatric pallet allows patients to be positioned supine, feet first, or head first (for brain scans) and features various restraints to immobilize the knees, elbows and shoulders of young patients during acquisition.

Width	25.4 cm (10 in.)
Length	129.9 cm (51.1 in.)
Weight	6.4 kg (14.16 lb.)
Height	17.1 cm (6.8 in.)
Pallet Material	Carbon Fiber/Laminated Wood
Pallet Thickness	6.35 mm (0.25 in.)
Narrow Portion	3.05 mm (0.12 in.)
Pallet Width SPECT	25.4 cm (10 in.)
Narrow Portion	190.5 mm (7.5 in.)
Attenuation @ 140 keV	<10%
Max. Patient Weight	27 kg (60 lb.)
Max. Deflection of Patient Pallet	<6.35 mm (<0.25 in.)
Horizontal Motion Range	114.3 cm (45 in.)



e.cam^{duet} / e.cam⁺

General Imaging Including Positron Emission Tomography

In addition to taking full advantage of the existing advanced features of Siemens HD⁴ digital detectors, the e.cam⁺ and e.cam^{duet} incorporate sophisticated PET-based detector technologies for achieving exceptionally high system performance.

e.cam^{duet}

The e.cam^{duet} high-performance, multipurpose gamma camera is a second-generation camera specifically designed for both coincidence and single-photon applications. The e.cam^{duet} is a unique camera that combines 25.4 mm (1.0 inch) segmented NaI crystals and PET-based high-performance detectors to dramatically increase system sensitivity and coincidence count rate. The result is a camera system offering superior performance and image quality for low-, medium-, and high-energy applications.

The e.cam⁺ coincidence option

specifically addresses the needs of healthcare institutions seeking to expand the clinical capabilities of their e.cam systems to include FDG imaging capability. This upgrade is easy to use and provides a fully integrated, low cost approach to performing certain studies previously available only on dedicated Positron Emission Tomography (PET) systems. e.cam⁺ includes two ultrahigh-efficiency HD⁴ detectors equipped with 5/8-inch (15.9 mm) NaI crystals, special high count rate electronics, and axial shields to reduce scatter and random coincidence events for improved image contrast. The coincidence software includes a fully integrated, easy-to-use, graphical user interface to provide complete e.cam⁺ coincidence acquisition and processing functionality.

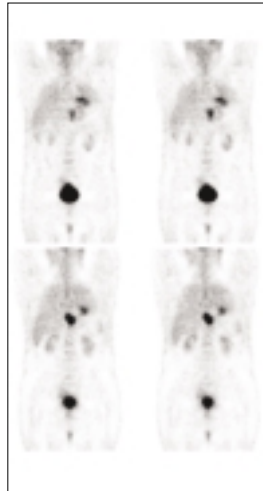
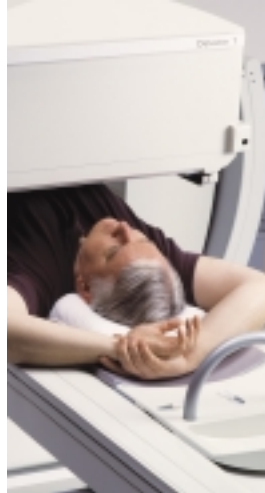

FDG Coincidence

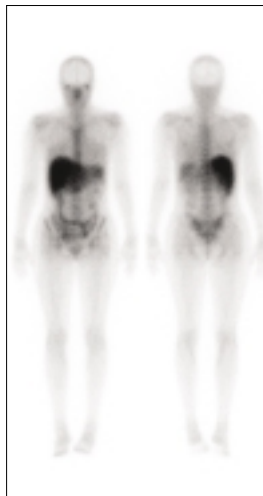

Gallium Whole Body

e.cam^{duet} and e.cam⁺

Advanced features include:

- PET-based HD⁴ detector technologies for superior image contrast and lesion detectability.
- High-count-rate coincidence electronics
- Contrast-enhancing axial shields and on-the-fly Compton pair rejection
- Early event pulse shape discrimination for improved image contrast and better signal-to-noise ratio.
- Continuously variable pulse integration times for optimal energy and spatial resolution.
- Pile-up correction on each individual PMT for improved energy and spatial resolution at high count rates.
- Random events correction for improved image contrast.
- Fully automated peak shift tracking at high count rates for improved signal-to-noise ratio.

Profile Nonuniform Cardiac Attenuation Correction — Improving Clinical Accuracy of Cardiac SPECT Procedures

Profile Cardiac Attenuation Correction

The e.cam Profile attenuation correction system offers improved cardiac SPECT imaging accuracy over an extended range of patient sizes. A unique, multiple-line source array produces a profiled transmission source shape. By weighting the activity levels in each of the individual lines, the transmission flux can be directed at the center of the patient where it is needed most. The overall activity level of the transmission source can be substantially reduced while significantly extending the range of measurable patient sizes up to 180 kg (400 lb.). Further, the Profile source array design inherently benefits from the natural decay of ^{153}Gd , extending the effective life of each line source to more than three years (twice the industry standard) while significantly reducing operating costs. When the system is not in use, the attenuation fixture conveniently and safely retracts against the gantry assembly.

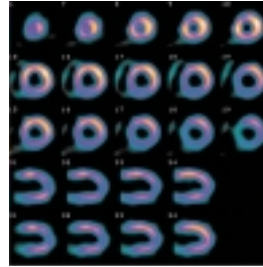

Uncorrected image

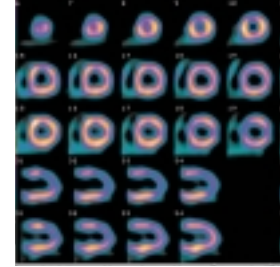

Corrected image

Profile Specifications	
Transmission Source Configuration	Multiple Line Array (MLA)
Number of Arrays per System	2
Number of Line Sources per Array	14 (7 pairs)
Transmission Isotope	^{153}Gd
Transmission Energy	100 keV
Transmission Activity (Total)	7.1 GBq (192 mCi) per system
Replenishment Interval	6 months
Replenishment Activity	4 line sources of 740 MBq (20 mCi)
Effective Source Life	3.5 years
Shutter Mechanism (Automatic)	Electric (fail-safe)
Cardiac FOV	53.3 cm x 19.7 cm (W x D) (21 in. x 7.75 in.) (W x D)
Acquisition Matrix	128 x 128 (no zoom)
Sampling Size	4.80 mm/pixel
Acquisition Type	90° SPECT and Gated SPECT
Acquisition Mode	NCO with prescan
Reconstruction Method	Iterative-W Reconstruction
Reconstructed Voxel Size	4.80 mm ³ or 6.20 mm ³
Resolution Recovery	Yes (collimator deblurring)
Supported Emission Isotopes	^{201}Tl and $^{99\text{m}}\text{Tc}$
Supported Collimators	LEHR
Transmission Scatter Correction	Yes, 3-window method
Emission Scatter Correction	No
Supported Patient Weight	up to 180 kg (400 lb.)
QC Interval	1 month (SPECT blank scan)
$^{99\text{m}}\text{Tc}$ Protocol	Simultaneous Emission/ Transmission
^{201}Tl Protocol	Pseudo-Sequential (single rotation)

Transmission Flux through Patient Center
Profile compared to scanning line source technique

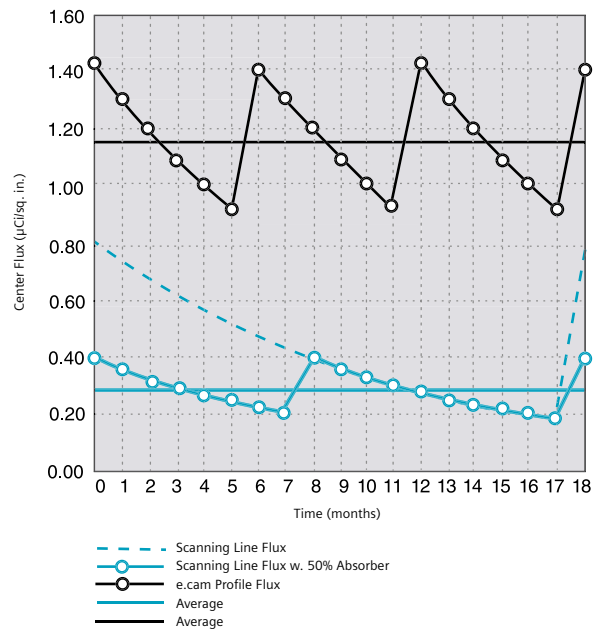

Notes:

- Scanning line flux curves are based on a moving line design with 9.25 GBq (250 mCi) activity using a 50% absorber to reduce the blank scan count rate and extend overall source life to 18 months.
- Profile numbers are based on a multiple line array with seven line pairs and a total of 3.7 GBq (100 mCi) activity.
- Even though the Profile system uses significantly less activity, the flux through the center of the patient (where it matters most) is consistently over four times higher on average.

e.cam Signature Series

Features and Options

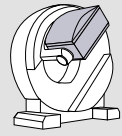

e.media

e.media is an exciting new optional patient information and education system that can make an impact in the area of patient comfort, reducing patient movement and associated motion artifacts. e.media can also be used for hospital promotions, patient education, and staff training presentations.

e.soft P / e.soft ^{turbo}

For a step up in performance and speed, choose the e.soft P workstation. The e.soft ^{turbo} package offers the highest speed, capacity, and performance. A state-of-the-art flat panel display produces high-quality multimodality images.

Flash 3D

Flash 3D is Siemens innovative iterative reconstruction algorithm that provides higher image contrast, higher image resolution, more accurate tumor shape and location, and decreased image noise artifacts.

Profile Attenuation Correction Option

Profile Attenuation Correction features a unique multiple ¹⁵³Gd line source array that significantly enhances the sensitivity and specificity of myocardial perfusion SPECT by correcting for the nonuniform attenuation from organs surrounding the heart.

e.cam⁺ Coincidence Option

Incorporates many of the technologies developed for dedicated PET. The system features Siemens proprietary HD⁴ PET-based detectors, high count rate electronics, axial shields, and coincidence software resulting in superior image contrast and lesion detectability.

Mobile e.cam

The mobile environment package allows installation of a fully-functional e.cam system in a wide variety of trucks and coaches. The technologist-friendly restraints secure the system for travel in minutes.

DETECTORS

GANTRY

BED

WORKSTATION

COLLIMATORS
one collimator set must be selected

OPTIONS

Features and Options	e.cam Standard	
Number of Detectors	1	
Detector Orientation	N/A	
3/8" Crystal	Choice	
5/8" Crystal	Choice	
1.0" Segmented e.cam ^{duet} Detector	N/A	
Automatic Body Contouring	Optional	
Caudal/Cephalic Tilt	Optional	
Detector Touchpad Sensors	Standard	
HD ⁴ High-Performance Detector	Standard	
Pass-through Open Gantry Design	Standard	
Patient Positioning Monitor (PPM)	Standard	
e.media Patient Comfort and Education Package	Optional	
Integrated Source Holder	Standard	
Left or Right Side Patient Imaging Bed	Choice	
Ultrathin Pallet with Integrated Arm Support	Standard	
Planar (Static) Acquisition	Standard	
Dynamic Acquisition	Standard	
Whole Body Acquisition	Optional	
Cardiac SPECT Acquisition (76° and 90°)	N/A	
General SPECT Acquisition	Standard	
Whole Body SPECT (Tomo) Acquisition	Optional	
Gated Acquisition	Standard	
Gated SPECT Acquisition	Standard	
Dynamic SPECT (Tomo) Acquisition	Standard	
Mammography Pallet	Optional	
Pediatric Pallet	Optional	
Cardiac Arm/Head Rest	Standard	
Brain SPECT Head Support	Standard	
ECG Gate/Strip Chart	Optional	
e.soft Workstation	Standard	
e.soft ^{turbo} Workstation	Optional	
e.soft A (acquisition) S/W	Standard	
syngo Multimodality Viewing Software	Standard	
Nu.LOGIC™ User-Defined Workflows	Standard	
Multilingual Interface	Optional	
Flexible Display	Standard	
Cardiac Quantification Software	Optional	
Flash 3D Iterative Reconstruction (Cardiac SPECT)	Optional	
Flash 3D Iterative Reconstruction (General SPECT)	Optional	
syngo 3D Display	Optional	
syngo Image Fusion	Optional	
Watsyn™ User Programming Language	Optional	
e.soft V (Viewing) Workstation	Optional	
e.soft P (Processing) Workstation	Optional	
e.soft AP (Acquisition & Processing)	Optional	
DICOM Worklist	Standard	
DICOM Print	Standard	
Remote Access	Optional	
Low-Energy High-Sensitivity Collimator	Optional	
Low-Energy All-Purpose Collimator	Optional	
Low-Energy High-Resolution Collimator	Optional	
Low-Energy Ultrahigh-Resolution	Optional	
Medium-Energy Collimator	Optional	
High-Energy Collimator	Optional	
Extra-High-Energy Collimator	Optional	
Fanbeam Collimator	Optional	
Pinhole Collimator	Optional	
Additional Collimator Cart	Optional	
Coincidence Acquisition (5/8" or 1.0" crystal)	N/A	
Profile Nonuniform Attenuation Correction	N/A	
CD Writer for e.soft	Optional	
Mobile Installation	Optional	
Upgrade to e.cam Variable Angle	N/A	
Upgrade to e.cam ^{duet}	N/A	
Single to Dual Detector Upgrade	Optional	

e.cam Signature Series

Room Layout Examples

System with left side patient access shown in large room.

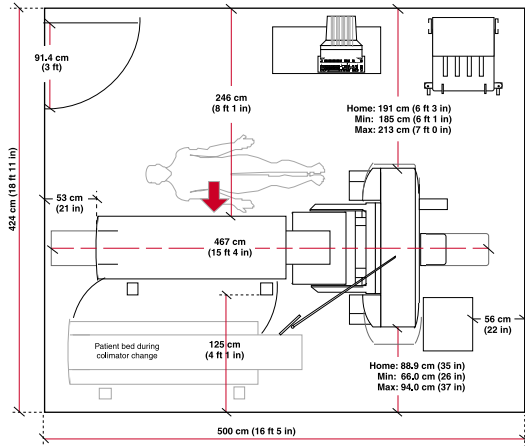

System with right side patient access shown in small room.

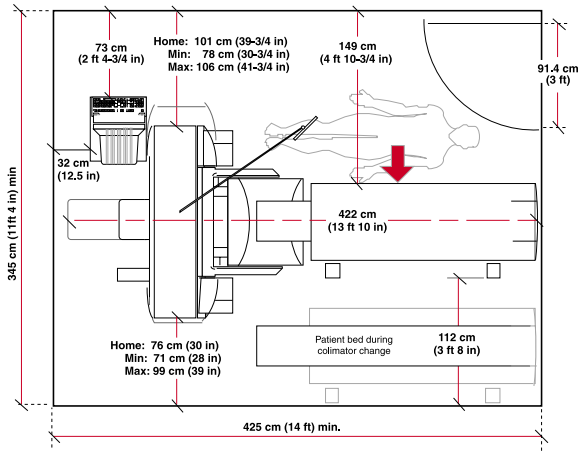

Diagonal configuration

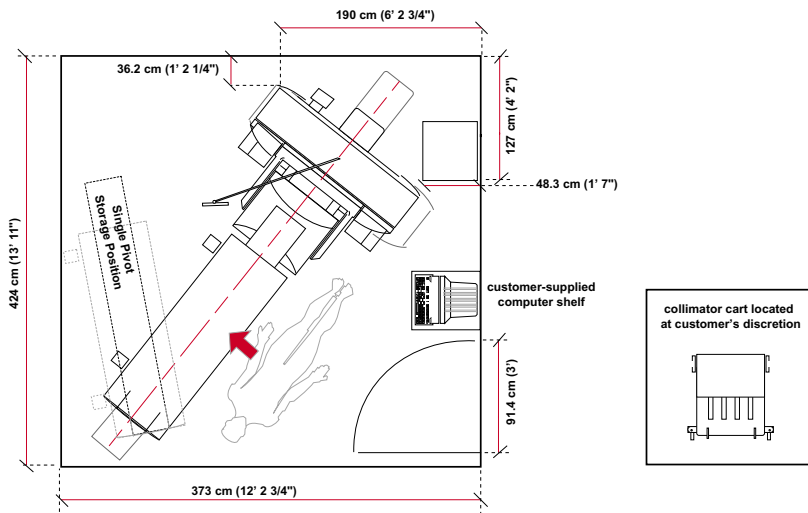

ISO 9001 certified, meeting internationally recognized quality standards for good manufacturing practices. e.cam is a registered trademark of Siemens Medical Solutions USA, Inc. e.cam^{duet} and BiCore are trademarks of Siemens Medical Solutions USA, Inc. e.soft and Nu.LOGIC are trademarks of Siemens Medical Solutions USA, Inc. and Toshiba Corporation. syngo is a registered trademark of Siemens AG. Watsyn is a trademark of Research Systems, Inc. Siemens reserves the right to modify the design and specifications contained herein without prior notice. Product performance depends on the choice of system configuration.

Please contact your local Siemens Sales Representative for the most current information or contact either of the addresses listed below.

© 2002 Siemens Medical Solutions USA, Inc. All rights reserved.
 All photographs © 2002 Siemens Medical Solutions USA, Inc. All rights reserved.
Note: Original images always lose a certain amount of detail when reproduced.

Siemens Medical Solutions USA, Inc.
 Nuclear Medicine Group
 2501 N. Barrington Road
 Hoffman Estates, Illinois 60195
 Telephone: (847) 304-7700
 Fax: (847) 304-7712

Siemens Aktiengesellschaft
 Medical Solutions Group
 Henkestraße 127
 91052 Erlangen, Germany
 Telephone ++49 9131 84-0
 SiemensMedical.com/nuclear

Siemens **Medical**
Solutions that help

Order No. A91004-M2310-G029-03-7600
 Printed in the USA
 PA 110210